

**Design and Modeling of Boring Fixture for Roller Stand**

Fixture Design

Kamlesh R Der<sup>1</sup>, Hardik N Chauhan<sup>2</sup>, Bhupat V Kavadi<sup>2</sup><sup>1</sup>Mechanical Engineering, Government Engineering College-Bhuj<sup>2</sup>Mechanical, Atmiya Institute of Technology and Science-Rajkot<sup>3</sup>Mechanical Engineering, Government Polytechnic-Amreli

**Abstract-** A Fixture is a device that must be able to position, hold support the work piece throughout machining operation. Generally used in mass and medium production.. This paper aims to provide sufficient condition to establish correct relation to work piece and fixture in terms of positioning and locating work with the machine tool to have fine dimensional accuracy. The cast component, roller stand is main part of cutting machine. The major operation to be performed are boring and milling slot. The real time criteria is to bore exact hole and slot with respect to each other with dimensional accuracy within limit. The research work include 3D assembled and exploded view of fixture and its components using Cero Elements and AutoCAD 2012 in addition to detail & Assembly drawing. Based on this a trial baase model is preared and the validation of the fixture is carried out through process capability study of measured bore diameter

**Keywords-** Boring Fixture, Modelling, Process Capability, CNC machine

**I. INTRODUCTION**

A fixture is a device that is used to locate, clamp and support work piece during machining, assembly and inspection operation. The basic criteria is to provide adequate stability to work piece along with correct positioning against cutting tool by holding it firmly without any deformation. A proper design establish proper relation between work piece and cutting tool and hold work piece with optimum clamping force to minimize geometric error and deformation in work piece. Fixture design involves setup planning as the number of operation that carried out on the work piece depends on geometry of work piece and machining capability, each setup is unique in terms of overall requirement of design criteria. Setup planning involves determination of operations and part geometry. A location layout and clamping arrangement is another task that prompt impact on better design of fixture. A 3-2-1 principle of location is widely accepted principle for correct location. Clamping force calculation helps to provide adequate clamping force, as low clamping force will create vibration and tends to lift the work during machining, results in poor machining. On other hand unnecessary clamping force create geometrical change in work piece. A 3Dimensional model will help to provide better view to verify correct relations with each components of fixture as well as provide necessary conditions for further modification and analysis.

**II. DESIGN AND MODELING**

This design and development is based on Case based reasoning method under guidance of industrial expert who based on the similar problem faced in past decide the change in the designing and modeming process. A problem solving CBR use past methodology to overcome the new problem

**2.1 Design Criterion**

The basic criterion is to design fixture for two semicircular bore with dimensional accuracy of  $50^{+0.05}_{+0.025}$  and to maintain distance between the two centers of the bore along with other operations that required to finish the component.

**2.2 Input Condition**

Component: Gray cast iron 300mm x330 mm (EN-GJL-200 (FG 200, Indian standard)

Initial bore Size:  $\phi$  42

Machine: VMC PX20 (Jyoti CNC Automation Ltd.)

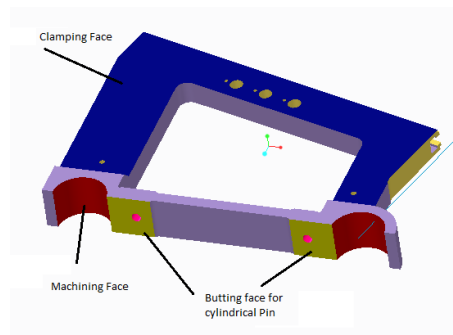

Figure 1. Model of components

### 2.3 Fixture Design process

It consist of setup planning to determine no of setup required (3 in this components) to manufactured complete component followed by Fixture planning for each setup to determine locating and clamping requirements. Components of fixture designed and modeled in creo parametric based on acting forces on the component during manufacturing for suggested cutting tool and machine tool. Along with Boring operation of semicircular hole there are 9 more operations performed in first setup

### 2.4 Force Calculation:

Input parameter are

Boring tool diameter  $D = \phi 50 \text{ mm}$

Material: EN-GJL-200

Pre-drilled  $\phi 42 \text{ mm}$

Spindle speed  $n = 1100 \text{ rpm}$

Cutting Speed =  $100 \text{ m/min}$

Feed  $f_n = 100/1100 = 0.091 \text{ mm/rev}$

Lead angle  $\kappa = 90^\circ$

$K_c = 1857$  (by ISCAR tool)

Spindle Speed  $V_c = \frac{\pi D n}{1000} = \frac{3.14 \times 50 \times 1100}{1000} = 172.7 \text{ m/min}$

Cutting Depth  $a_p = \frac{(D-d)}{2} = \frac{(50-42)}{2} = 4 \text{ mm}$

Cutting Cross section  $A = a_p \times f_n = 4 \times 0.091 = 0.364 \text{ mm}^2$

Chip Thickness  $h = f_z \sin K = 0.091 \times \sin 90^\circ = 0.091 \text{ mm}$

Cutting Force  $F_c = A \times K_c = 0.364 \times 1857 = 675.94 \text{ N}$

Cutting Torque  $M_c = (F_c \times d_m)/2 = (675.94 \times 0.046)/2 = 15.54 \text{ Nm}$

Cutting Power  $P_c = (2 \pi n) / 60000 = (2 \times 3.14 \times 1100)/60000 = 1.78 \text{ kw}$

The following calculation verified by *ISCAR* software for machining calculation

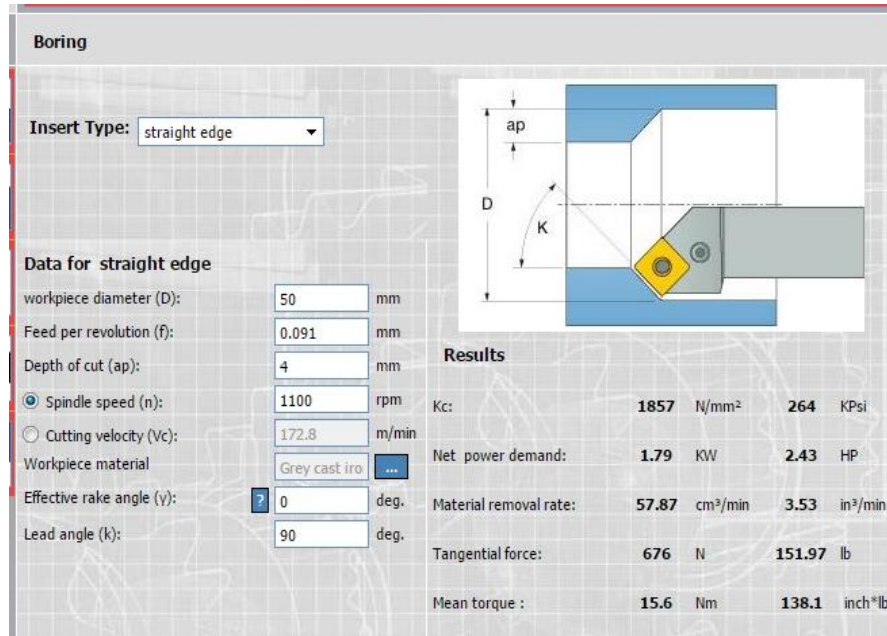

Figure 2 Machining Force Calculation by ISCAR software

## 2.5 Clamp selection based on clamping force

Cutting force may varies as cutter enters and leaves the work piece and throw away an extra load on the clamps. Clamps should not be loosen by vibration, which are caused by interrupted cutting by milling cutter at start and end of operation. Also clamps must be located opposite to the locating surface and must be designed in such a way that it make ease in loading and unloading of parts. In current problem there is maximum 675N cutting force developed during semicircular boring, in other operation of the first setup like drilling and tapping, the cutting force required is less than that of required in the boring operation, so the selection of clamp type, its size and number of clamp required is based on boring operation.

Clamping force must be taken greater than the cutting force, here it is assumed to be 2 times greater because of uncertainty of magnitude of external force acting on the component, variation of properties of material, variation in dimension due to poor workmanship, dynamic nature of load and many assumptions made in calculations.

$$\text{Clamping force } P = \frac{\text{Factoe of Safety} \times \text{Cutting Force}}{\text{Static Coefficient of Friction}} = \frac{2 \times 675}{19} = 7105\text{N}$$

For medium carbon steel, tensile strength  $\sigma_t = 800 \text{ MPa} = 800 \text{ N/mm}^2$

$$\text{So permissible tensile stress} = \frac{\text{Max Tens ile stress}}{\text{Factor of Safety}} = \frac{800}{6} = 133.33 \text{ N/mm}^2$$

$$\text{Load } P = \pi/4 \text{ dc}^2 \times \sigma_t$$

So,  $\text{dc} = 8.23\text{mm}$

Core diameter  $\text{dc}$  is taken as 0.8 nominal diameter  $d$

$$\text{So, Nominal diameter } d = \text{dc} / 0.8 = 8.23 / 0.8 = 10.24\text{mm}$$

For this a M10 bolt is selected using PSG design data book

For effective clamping the 1/3 of the clamp length provided in between bolt and work piece as shown in the figure

3.4

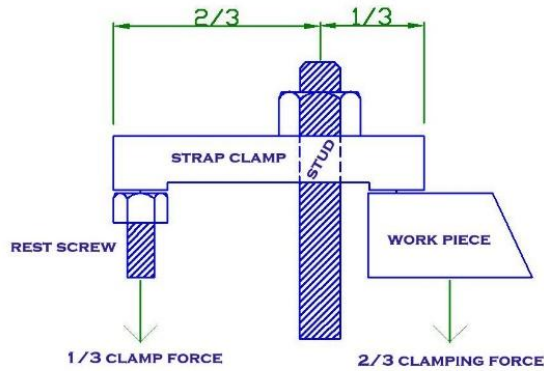

Figure 3 Strap clamp used to hold the work piece

Using PSG design Data book modified strap clamps are designed,

Bolt size = M10

Width of clamp  $w = 30\text{mm}$

Height of clamp  $h = 30\text{mm}$

Slot width  $c = 12\text{mm}$

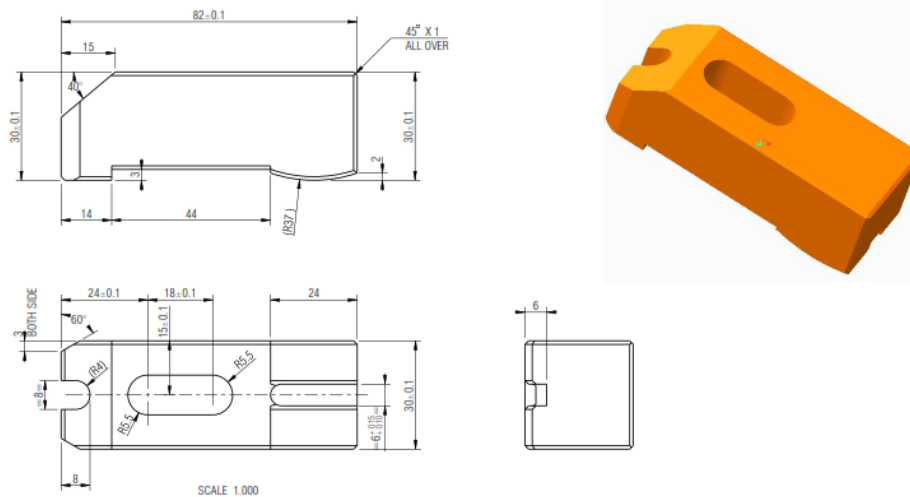

Figure 4 Strap clamp modeled in creo Parametric

### III. UNIT DESIGN WITH MODEL IN CREO PARAMETRIC FOR FIRST SETUP OF FIXTURE

The major part of designing any fixture involves force calculation and clamping selection, beside this there are requirement of correct location of parts in fixture in order to orient part in unique position every time when fixture is loaded for machining. To ensure this a 3-2-1 principal of location as described earlier is used. For perfect location a resting pad with knurling hatched and locating support as shown in drawing is fabricated. To hold the entire unit a robust plate is the prime requirement. All this components of the fixture is developed in CAD modelling using Creo Parametric software.



Fig 5 Base plate showing 3-2-1 location

Fig 6 Fixture with Clamps

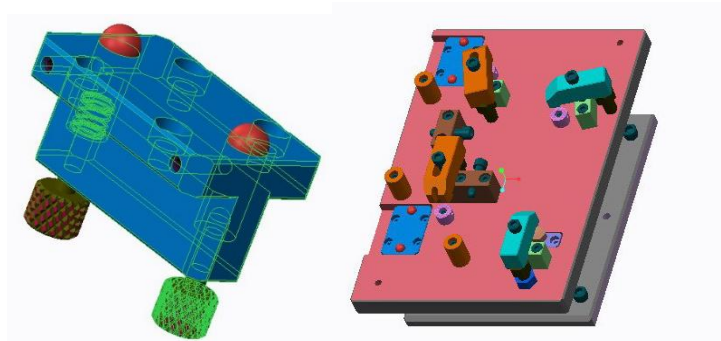

Fig 7 Plunger Assembly

Fig 8 Fixture with Plunger support



Figure 9 First setup of boring Fixture

In this fixture 20 major components are designed and assembled. Each part is prepared in Creo 3.0 modeling software using features like extrude, revolve, hole chamfer, draft etc. after modeling of every part it is assembled providing various constraints like distance, coincide, parallel and normal

#### IV. VALIDATION

A working model is manufactured based on the creo parametric model, during trial run various measurements are taken and process capability study is carried out to validate the fixture against basic requirement of the dimensional accuracy.

##### 4.1 Process Capability

Process capability is a simple statistical measure which shows that how close the process is with the specified values. Higher the number, better will be the process.  $C_p$ ,  $C_{pl}$ ,  $C_{pu}$  and  $C_{pk}$  are two numbers that are used in the study of process capabilities.

$C_p$  process capability, a simple straight forward indicator of process capability  $C_{pk}$  Process capability Index, adjustment of  $C_p$  for the effect of non-centered distribution

“ $C_{pk}$  is an index which measures how close the process is running to its specification limit, relative to the natural variability of the process. The larger the index, less likely that any measured value fall outside the range.” -Neil Polhemus  
 $C_{pk}$  measure how close you are to your target and how close you are to around your average performance. A person may be performing with minimum variation but he can be away from his target towards one of the specification limit which indicates lower  $C_{pk}$ , whereas  $C_p$  will be high. On the other hand a person may be on average to the target but variation in performance is high (within limit) in such case to the  $C_{pk}$  is lower and  $C_p$  is high.  $C_{pk}$  will be higher only when you are meeting target consistently with minimum variation.

**5.2 Process Capability Indices**

USL = Upper Specification Limit

LSL = Lower Specification Limit

$\bar{X}$  = Mean of the process

$\sigma$  = Standard deviation of the process

Index	Equation	Usage
$C_p$	$\frac{USL - LSL}{6\sigma}$	Process capability for two -sided specification limit, irrespective of process center.
$C_{pu}$	$\frac{USL - \bar{X}}{3\sigma}$	Process capability relative to upper specification limit
$C_{pl}$	$\frac{\bar{X} - LSL}{3\sigma}$	Process capability relative to lower specification limit
$C_{pk}$	$\text{Min} \left[ \frac{USL - \bar{X}}{3\sigma}, \frac{\bar{X} - LSL}{3\sigma} \right]$	Process capability for two -sided specification limit accounting for process centering.

Table 1 Process Capability Indices

If  $\bar{X}$  is target, then  $C_p = C_{pk}$

$C_{pk}$  will be always less than or equal to  $C_p$  ( $C_{pk} \leq C_p$ )

The defect levels or parts per million non-conforming were computed for different  $C_{pk}$  values using the Z scores and the percentage area under the standard normal curve using normal deviate tables.

This process is so good that even if the process mean shifts by as much as +/- 1.5 sigma the process will produce no more than 3.4 non-conforming parts per million.

Capability Index	Estimation of Process
$C_p = C_{pk}$	Process is placed exactly at the centre of the specification limits.
$C_p < 1$	Process is not adequate
$1 \leq C_p \leq 1.33$	Process is adequate
$C_p \geq 1.33$	Process is satisfactory enough
$C_p \geq 1.66$	Process is very satisfactory
$C_p \neq C_{pk}$	Process is inadequate, new parameters must be chosen.

Table 2 Process Capability Estimation

**5.3 Process capability study for first semicircular Bore**

Sub Group	Sample Size				$\bar{x}$	R
	1	2	3	4		
1	50.032	50.03	50.035	50.03	50.032	0.005

2	50.036	50.036	50.039	50.033	50.036	0.006
3	50.032	50.034	50.032	50.032	50.033	0.002
4	50.04	50.032	50.035	50.036	50.036	0.008
5	50.036	50.034	50.037	50.035	50.036	0.003
6	50.035	50.035	50.036	50.036	50.036	0.001
7	50.039	50.037	50.038	50.039	50.039	0.002
8	50.032	50.038	50.034	50.031	50.034	0.007
9	50.035	50.04	50.035	50.038	50.037	0.005
10	50.04	50.039	50.038	50.038	50.039	0.002
11	50.042	50.037	50.039	50.042	50.04	0.005
12	50.038	50.038	50.034	50.036	50.037	0.004
13	50.038	50.036	50.034	50.039	50.037	0.005
14	50.042	50.037	50.039	50.035	50.039	0.007
15	50.035	50.036	50.031	50.038	50.035	0.007
16	50.034	50.034	50.031	50.039	50.035	0.008
17	50.036	50.033	50.034	50.035	50.035	0.003
18	50.039	50.038	50.036	50.035	50.037	0.004
19	50.036	50.035	50.036	50.034	50.036	0.002
20	50.038	50.039	50.033	50.036	50.037	0.006
21	50.036	50.038	50.038	50.038	50.038	0.002
22	50.035	50.035	50.036	50.039	50.037	0.004
23	50.038	50.042	50.042	50.037	50.04	0.005
24	50.034	50.039	50.034	50.037	50.036	0.005
25	50.033	50.034	50.035	50.039	50.036	0.006
					$\bar{X}$	$\bar{R}$
Mean	50.0365	50.0363	50.0357	50.0363	50.0366	<b>0.0046</b>
Sdev( $\sigma$ )	0.0028	0.0027	0.0026	0.0028		0.002234
<b>3<math>\sigma</math></b>	0.0084	0.0081	0.0078	0.0084		0.006702
<b>6<math>\sigma</math></b>	0.0168	0.0162	0.0156	0.0168		0.013405
<b>C<sub>PU</sub></b>	1.608	1.692	1.834	1.631		1.41316
<b>C<sub>PL</sub></b>	1.37	1.396	1.372	1.346		1.417428
<b>C<sub>P</sub></b>	1.37	1.396	1.372	1.346		1.41316
<b>C<sub>PK</sub></b>	1.489	1.544	1.603	1.489		1.415294
<b>Acceptance</b>	<b>C<sub>P</sub> &amp; C<sub>PK</sub> ≥ 1.33</b>					

Table 3 measurement of bore

### Calculations for Control Limits

From the data selected, the control limits are calculated by calculating Average ( $\bar{X}$ ), Ranges ( $R$ ) and Standard Deviation ( $\sigma$ ). Computation for control limits are as follows:

$$\text{Average } \bar{X} = \frac{\sum x}{N} = 50.0366 \quad \text{Range } \bar{R} = \frac{\sum R}{N} = 0.0046 \quad \text{Standard deviation } \sigma = \frac{\bar{R}}{d_2} = \frac{0.0046}{2.059} = 0.00223$$

#### For $\bar{X}$ chart

$$\text{Upper Control Limit (UCLX)} = \bar{X} + A_2 \bar{R} = 50.0461$$

$$\text{Lower Control Limit (LCLX)} = \bar{X} - A_2 \bar{R} = 50.0366$$

#### For $R$ chart

$$\text{Upper Control Limit (UCLX)} = D_4 \bar{R} = 0.01051$$

$$\text{Lower Control Limit (LCLX)} = D_3 \bar{R} = 0$$

( $A_2 = 0.729$ ,  $d_2 = 2.059$ ,  $D_4 = 2.282$  depending on no of sample take in sub-group)

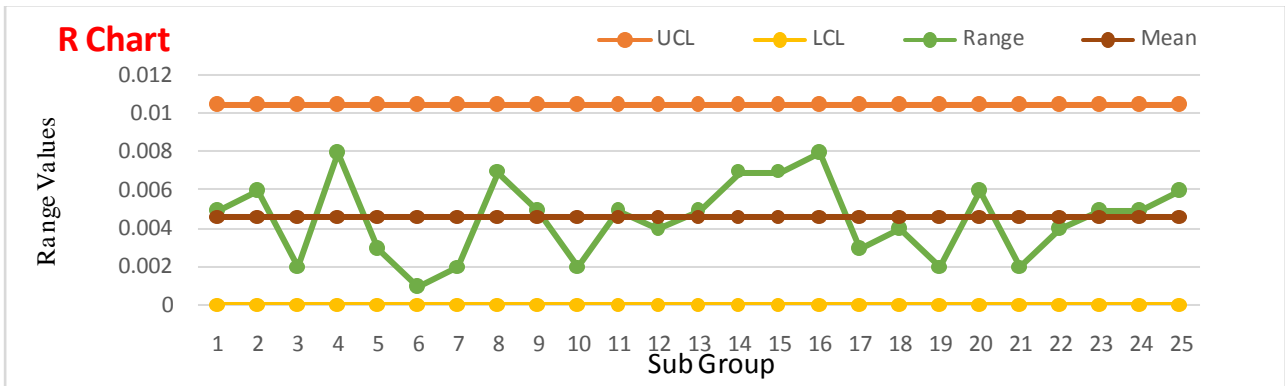
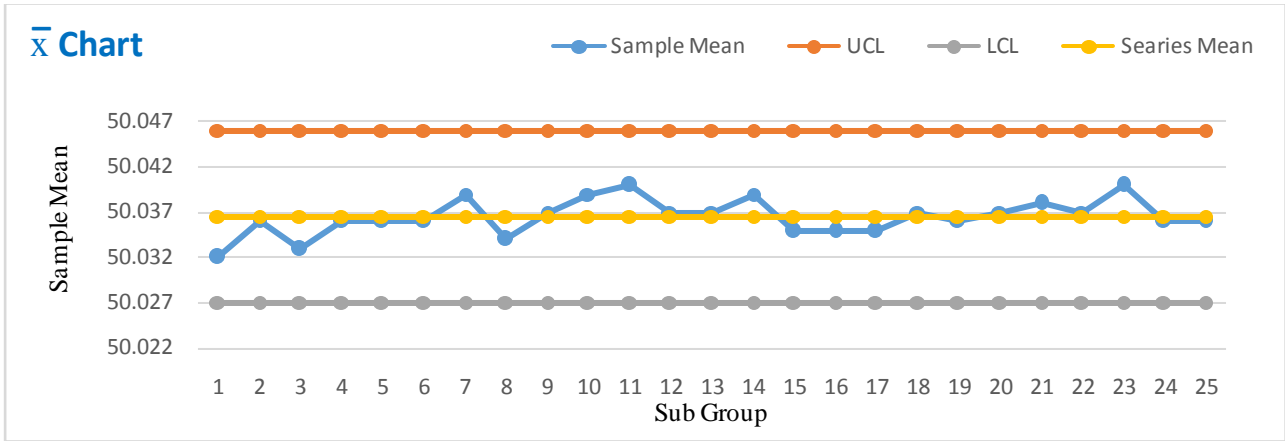

Figure 10  $\bar{X}$  and R Chart

**Calculation for  $C_{PK}$  &  $C_P$**

$$C_{PU} = \frac{USL - \bar{X}}{3\sigma} = \frac{50.050 - 50.036}{0.0067} = 1.41316$$

$$C_{PL} = \frac{\bar{X} - LSL}{3\sigma} = \frac{50.036 - 50.025}{0.00783} = 1.41743$$

$$C_P = \text{Min} \left[ \frac{USL - \bar{X}}{3\sigma}, \frac{\bar{X} - LSL}{3\sigma} \right] = 1.41316$$

$$C_{PK} = \frac{USL - LSL}{6\sigma} = \frac{50.050 - 50.025}{0.01566} = 1.41529$$

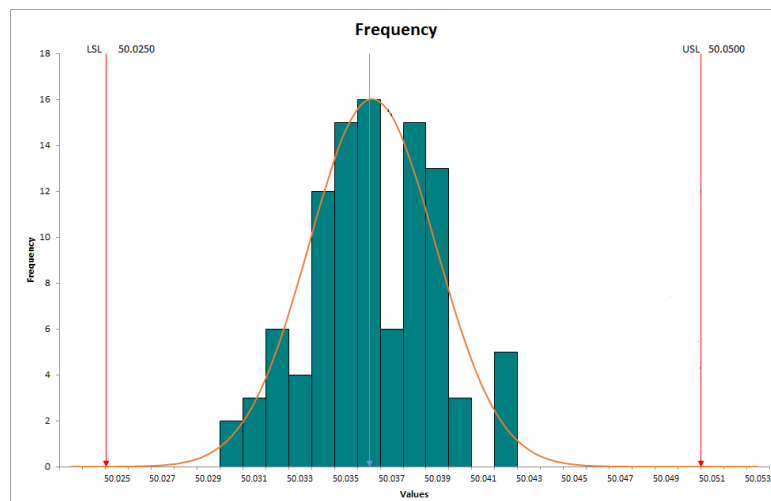

Figure 11 Frequency Histogram



## VI. CONCLUSION

The aim of this fixture is to make it robust as well as to satisfy dimensional accuracy of critical elements like semicircular bore at two ends and the center distance between this two holes which are required to machine with specific tolerances. As the component is of cutting machinery required to produce in medium volume, the simple conventional fixture selected. Four clamps support are provided to reduce deflection of work. Swinging type clamps provides easy loading and unloading of the part. Plunger arrangement facilitate the unloading of part due to jamming against cutting force.

From the result of machining trial and process capability study it is conclude that,

- Fixture can hold the work piece against cutting force
- Dimensional accuracy of semicircular hole  $50^{+0.005}_{-0.025}$  achieved within given tolerance as measured in trial run
- Achieved process capability (Cp and Cpk) more than 1.33

## VII. FUTURESCOPE

This conventional fixture can be replaced by Hydraulic or Pneumatic fixture. The setup can be reduced from three to two by combining some operations in similar setup. Approach of modular fixture make it more convenient to design as well as fabricate future fixture.

## REFERENCES

- [1] Rétfalvi Attila, Michael Stampfer, SzeghImre, Fixture and setup planning and fixture configuration system, Forty sixth CIRP conferences of manufacturing system, Elsevier, 2013
- [2] Parvesh Kumar Rajvanshi, Dr. R.M.Belokar, Improving the process capability of a boring operation by the application of statistical techniques, International journal for scienc and research, volume 3 issue 5, 2012
- [3] U. Farhana, M. Tolouei-Rada, Design of modular fixtures using a 3D-modelling approach, 19th international congress on modelling and simulation, Perth, AUS, ECU publication, 2011
- [4] L Fan, Shenthilkumar, Development of robust fixture locating layout for machining work piece, Journal of Engineering Manufacturers, SAGE on behalf of Institute of Mechanical Engineers, 2010
- [5] Nirav P. Maniar, Dr. D. P.Vakharia, Chetan Patel, Design & manufacturing of 10 operations boring fixture for machining connecting rod on VMC, Total Engineering, analysis and Manufacturing technologies, Team-teach, 2008
- [6] Haiyan Dang, Shreyes N Malkote, Determination of minimum clamping forces for dynamically stable fixture, International journal of Machine tools and manufacture, Elsevier, 2006
- [7] Y. Wang, X. Chen, N. Gindy, Deformation Analysis of Fixturing for Work piece with Complex Geometry, Key Engineering Materials, vol 291-292, Trans Tech Publication, Switzerland, 2005
- [8] Anand Raghu, Shreyes N Melkote, Analysis of the effect of fixture clamping sequence on part location errors, International journal of Machine tools and manufacture 44, Elsevier, 2003
- [9] Djordje VUKELIC, Janko HODOLIC, Computer Aided Fixture Design
- [10] John S Oakland, Statistical Process Control, Butterworth Heinemann
- [11] Edward G Hoffman, Jig and Fixture Design, 3rd Edition, Delmar Publishers Inc., Clifton park, NY
- [12] Andrew Y C Nee "An Advanced Treatise on Fixture Design and Planning",2004  
[www.worldscientific.com/doi/suppl/10.1142/5671/suppl\\_file/5671\\_chap1.pdf](http://www.worldscientific.com/doi/suppl/10.1142/5671/suppl_file/5671_chap1.pdf)
- [13] P H Joshi, Jigs and Fixtures Design Manual, 2nd Edition, McGraw-Hill Publication, 2003
- [14] Yiming Rong, Samuel Huang, Zikunhou, Advanced Computer Aided Fixture Design, British Library Cataloging -in publication data, 2005
- [15] [www.jyoti.co.in/company\\_profile.aspx](http://www.jyoti.co.in/company_profile.aspx)
- [16] <http://mpwr.iscar.com/machiningpwr/machiningpower.wg x>
- [17] [http://www.sandvik.coromant.com/en-gb/knowledge/technologies/silent\\_tools/formulas\\_and\\_definitions/pages/default.aspx](http://www.sandvik.coromant.com/en-gb/knowledge/technologies/silent_tools/formulas_and_definitions/pages/default.aspx)
- [18] M Chandru, C Padmanabha, Design and fabrication of wedge milling fixture presented at BHEL